

# BLN0x1R20

Barcode Line Scanner CCD array



**Operating Instructions**

# Index

<b>1. General</b>	<b>5</b>
1.1. Information Concerning these Instructions	5
1.2. Explanations of Symbols	5
1.3. Limitation of Liability	6
1.4. Copyrights	6
<b>2. For Your Safety</b>	<b>7</b>
2.1. Use for Intended Purpose	7
2.2. Use for Other than the Intended Purpose	8
2.3. Personnel Qualifications	8
2.4. Modification of Products	8
2.5. General Safety Precautions	8
2.6. Approvals and protection class	9
<b>3. Technical Data</b>	<b>10</b>
3.1. Scanner Connection	11
3.2. Housing Dimensions	12
3.3. Control Panel	12
3.4. Complementary Products (see catalog)	13
<b>4. Mounting Instructions</b>	<b>14</b>
<b>5. Initial Operation</b>	<b>14</b>
5.1. Initial Operation	14
<b>6. Function Descriptions</b>	<b>15</b>
6.1. Run	17
6.2. Pin Function	17
6.3. E/A Settings	17
6.3.1. Output – NPN/PNP	19
6.3.2. Output – NO/NC	19
6.3.3. Output – ON Delay	20
6.3.4. Output – OFF Delay	20
6.3.5. Output – Pulse Length	21
6.4. E/A Test	21
6.4.1. E/A Test – Testing A1 through A4	21
6.4.2. E/A-Test – Testing E1 through E4	22
6.5. Reading mode	22
6.6. Code Settings	23
6.7. Match code	23
6.8. Interface	23
6.8.1. Serial/Baude rate	24

6.8.2. Ethernet	24
6.8.2.1. IP-address	24
6.8.2.2. Subnet mask	24
6.8.2.3. Standard Gateway	25
6.8.2.4. DHCP	25
6.8.2.5. MAC Address	25
6.8.2.6. Network Reset	25
6.8.2.7. Accept	25
6.8.2.8. Cancel	25
6.9. Display	26
6.9.1. Display – Mode	26
6.9.2. Display – Intensity	26
6.10. Language	27
6.11. Info	27
6.12. Reset	27
6.13. Password	27
<b>7. Network Settings</b>	<b>28</b>
<b>8. Web-Based Configuration</b>	<b>28</b>
8.1. Invoking the Administration Interface	28
8.2. Overview Page	29
8.3. Device Settings	30
8.4. Read Cycle	33
8.4.1. Reading mode	33
8.4.2. Read timeout	33
8.4.3. Code	34
8.4.4. Preamble and Postamble Characters	34
8.4.5. Match code Parameters	34
8.4.6. Terminator	35
8.4.7. Match code	35
8.4.8. Current Match code	35
8.4.9. Match and Mismatch Performance	35
8.5. Code Settings	36
8.5.1. Code 39	36
8.5.2. Code 11	36
8.5.3. Code 128	36
8.5.4. Interleaved 2 of 5	37
8.5.5. Codabar	37
8.5.6. UPC/EAN	37
8.5.7. Code 93	37
8.5.8. Industrial 2 of 5	37
8.5.9. MSI Code	37
8.5.10. RSS-14 Expanded	37

8.5.11. RSS-14 Limited	38
8.5.12. RSS-14 Omnidirectional	38
8.5.13. Matrix 2 of 5	38
8.6. Digital I/O Settings	39
8.7. Diagnosis	40
<b>9. Maintenance Instructions</b>	<b>40</b>
<b>10. Proper Disposal</b>	<b>40</b>
<b>11. EU Declaration of Conformity</b>	<b>42</b>
<b>12. Change Index, Operating Instructions</b>	<b>42</b>

# 1. General

## 1.1. Information Concerning these Instructions

- These instructions apply to the product with ID code BLN0x1R20.
- They make it possible to use the product safely and efficiently.
- These instructions are an integral part of the product and must be kept on hand for the entire duration of its service life.
- Local accident prevention regulations and national work safety regulations must be complied with as well.
- The product is subject to further technical development, and thus the information contained in these operating instructions may also be subject to change. The current version can be found at [www.wenglor.com](http://www.wenglor.com) in the product's separate download area.



### NOTE!

The operating instructions must be read carefully before using the product and must be kept on hand for later reference.

## 1.2. Explanations of Symbols

- Safety precautions and warnings are emphasized by means of symbols and attention-getting words
- Safe use of the product is only possible if these safety precautions and warnings are adhered to
- The safety precautions and warnings are laid out in accordance with the following principle:



### ATTENTION-GETTING WORD!

#### Type and Source of Danger!

Possible consequences in the event that the hazard is disregarded.

- Measures for averting the hazard.

The meanings of the attention-getting words, as well as the scope of the associated hazards, are listed below.



### DANGER!

This word indicates a hazard with a high degree of risk which, if not avoided, results in death or severe injury.



### WARNING!

This word indicates a hazard with a medium degree of risk which, if not avoided, may result in death or severe injury.



### CAUTION!

This word indicates a hazard with a low degree of risk which, if not avoided, may result in minor or moderate injury.



### ATTENTION!

This word draws attention to a potentially hazardous situation which, if not avoided, may result in property damage.

**NOTE!**

A note draws attention to useful tips and suggestions, as well as information regarding efficient, error-free use.

### 1.3. Limitation of Liability

- The product has been developed in consideration of the current state-of-the-art and applicable standards and guidelines. Subject to change without notice.
- A valid declaration of conformity can be accessed at [www.wenglor.com](http://www.wenglor.com) in the product's separate download area.
- wenglor sensoric elektronische Geräte GmbH (hereinafter referred to as "wenglor") excludes all liability in the event of:
  - Non-compliance with the instructions
  - Use of the product for purposes other than those intended
  - Use by untrained personnel
  - Use of unapproved replacement parts
  - Unapproved modification of products
- These operating instructions do not include any guarantees from wenglor with regard to the described procedures or specific product characteristics.
- wenglor assumes no liability for printing errors or other inaccuracies contained in these operating instructions, unless wenglor was verifiably aware of such errors at the point in time at which the operating instructions were prepared.

### 1.4. Copyrights

- The contents of these instructions are protected by copyright law.
- All rights are reserved by wenglor.
- Commercial reproduction or any other commercial use of the provided content and information, in particular graphics and images, is not permitted without previous written consent from wenglor.

## 2. For Your Safety

### 2.1. Use for Intended Purpose

This wenglor product has to be used according to the following functional principle:

#### **Scanner 1D**

These Scanners detect 1D Codes with the help of Laser Light respectively Red Light. The light sent out to the barcode label is reflected back to a photo element and evaluated with a decoder.

**This product can be used in the following industry sectors:**

- Automotive industry
- Food industry
- Packaging industry
- Pharmaceuticals industry
- Clothing industry
- Plastics industry
- Consumer goods industry
- Paper industry
- Electronics industry
- Glass industry
- Printing industry
- Special machinery manufacturing
- Heavy machinery manufacturing
- Logistics
- Woodworking industry
- Steel industry
- Aviation industry
- Construction industry
- Chemicals industry
- Agriculture Industry
- Alternative energy
- Raw materials extraction

## 2.2. Use for Other than the Intended Purpose

- Not a safety component in accordance with 2006/42/EC (Machinery Directive)
  - The product is not suitable for use in potentially explosive atmospheres.
  - The product may only be used with accessories supplied or approved by wenglor, or combined with approved products. A list of approved accessories and combination products can be accessed at [www.wenglor.com](http://www.wenglor.com) on the product detail page.
- 



### **DANGER!**

#### **Risk of personal injury or property damage in case of use for other than the intended purpose!**

Use for other than the intended purpose may lead to hazardous situations.

- Observe instructions regarding use for intended purpose.
- 

## 2.3. Personnel Qualifications

- Suitable technical training is a prerequisite
  - In-house electronics training is required
  - Trained personnel must have uninterrupted access to the operating instructions
- 



### **DANGER!**

#### **Risk of personal injury or property damage in case of incorrect initial start-up and maintenance!**

Personal injury and damage to equipment may occur.

- Adequate training and qualification of personnel.
- 

## 2.4. Modification of Products



### **DANGER!**

#### **Risk of personal injury or property damage if the product is modified!**

Personal injury and damage to equipment may occur. Non-observance may result in loss of the CE marking and the guarantee may be rendered null and void.

- Modification of the product is impermissible.
- 

## 2.5. General Safety Precautions

- This operating instruction is part of the product and must be kept during its entire service life.
  - Read this operating instruction carefully before using the product.
  - Installation, start-up and maintenance of this product has only to be carried out by trained personal.
  - Tampering with or modifying the product is not permissible.
  - Protect the product against contamination during start-up.
  - Not a safety component in accordance with the EU Machinery Directive.
-



## 2.6. Approvals and protection class



### **WARNING!**

This is a class A device. This device may cause radio interference in residential areas. If this is the case, the implementation of appropriate measures may be demanded of the user.

---

### 3. Technical Data

Order Number	BLN0L1R20	BLN0L1H20
Light Source	Red Light	Red Light
Wave Length	625 nm	625 nm
Long Range	yes	
Wide Angle		yes
Read Range	30...520 mm	20...200 mm
max. Ambient Light	70000 Lux	70000 Lux
Opening Angle	40°	65°
Barcode Label Contrast	> 30 %	> 30 %
Supply Voltage	18...30 V DC	18...30 V DC
Current Consumption (U <sub>b</sub> = 24 V)	< 100 mA	< 100 mA
Scan rate	510 scan/s	510 scan/s
Temperature Range	-20...60 °C	-20...60 °C
Inputs/Outputs	4	4
Switching Output Voltage Drop	< 2,5 V	< 2,5 V
Switching Output/Switching Current	100 mA	100 mA
Short Circuit Protection	yes	yes
Ports Reverse Polarity Protection	yes	yes
Ports Overload Protection	yes	yes
Interface	RS-232*/Ethernet	RS-232*/Ethernet
Housing	Aluminum	Aluminum
Protection Class	III	III
Protection	IP67	IP67
Connection	M12×1	M12×1
Baud Rate	10 Mbit/s / 100 Mbit/s	10 Mbit/s / 100 Mbit/s
Transmission Mode	Full- /Half Duplex	Full- /Half Duplex
Webserver	yes	yes
Default IP	192.168.100.1	192.168.100.1
Auto-Crossover	yes	yes
Auto-Negotiating	yes	yes
Auto-Polarity	yes	yes

\* Maximum connection length: 30 m

## BLN0L1R20

Min. Resolution	Read Range	
0,076 mm	–	Code 39 (4 digits)
0,101 mm	60...130 mm	Code 39 (4 digits)
0,127 mm	55...170 mm	Code 39 (4 digits)
0,254 mm	30...350 mm	Code 39 (4 digits)
0,381 mm	45...520 mm	Code 39 (4 digits)
0,330 mm	40...390 mm	UPC/EAN (13 digits)
Scanning field width	200 mm	Code39 (0,330 mm)

## BLN0H1R20

Min. Resolution	Read Range	
0,076 mm	35...70 mm	Code 39 (13 digits)
0,101 mm	25...80 mm	Code 39 (4 digits)
0,127 mm	25...100 mm	Code 39 (4 digits)
0,254 mm	20...160 mm	Code 39 (4 digits)
0,381 mm	30...200 mm	Code 39 (4 digits)
0,330 mm	30...170 mm	UPC/EAN (13 digits)
Scanning field width	110 mm	Code39 (0,330 mm)

### 3.1. Scanner Connection

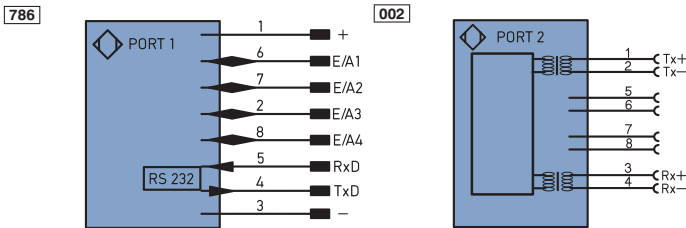
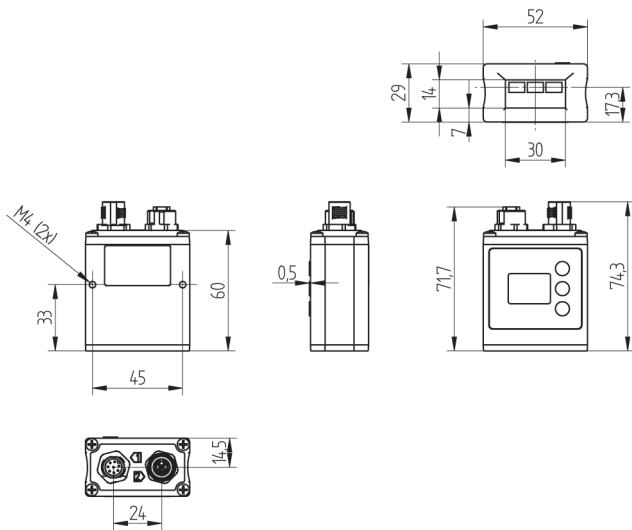

Figure 1: Plug 1

Figure 2: Plug 2

- + Supply Voltage „+“
- Supply Voltage „0 V“
- E/A Output/Input programmable
- RxD RS-232 receive path
- TxD RS-232 send path
- Tx+/- Ethernet send path
- Rx+/- Ethernet receive path

### 3.2. Housing Dimensions



### 3.3. Control Panel

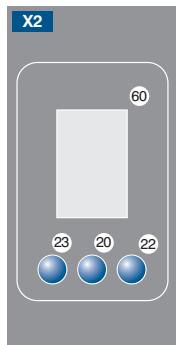

- 20 = Enter Button
- 22 = Up Button
- 23 = Down Button
- 60 = Display

### 3.4. Complementary Products (see catalog)

wenglor offers Connection Technology for field wiring.

#### Suiting Connection Technology No.

50

89

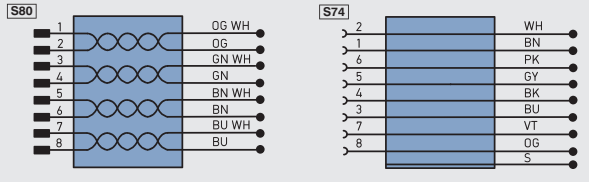

Connector cable M12×1, 8-pin (plug 1)

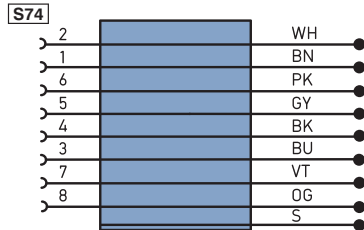

- ZAS89R201, M12×1 connector cable, 8-pin, 2 m, straight
- ZAS89R202, M12×1 connector cable, 8-pin, 2 m, angled
- ZAS89R501, M12×1 connector cable, 8-pin, 5 m, straight
- ZAS89R502, M12×1 connector cable, 8-pin, 5 m, angled
- ZAS89R601, M12×1 connector cable, 8-pin, 10 m, straight
- ZAS89R602, M12×1 connector cable, 8-pin, 10 m, angled
- ZAS89R701, M12×1 connector cable, 8-pin, 20 m, straight
- ZAS89R702, M12×1 connector cable, 8-pin, 20 m, angled

Interface cable (plug 1)

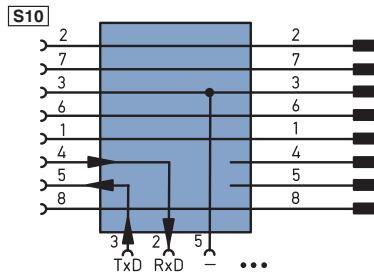

S232W3 Interface cable, M12×1, 8-pin, 1,5 m, angled

Connector cable M12×1, 8-pin (plug 2)

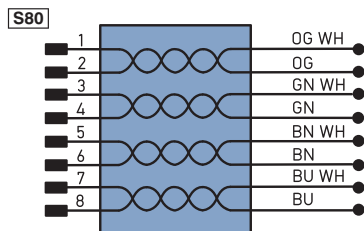

- ZAV50R201, M12×1 connector cable, 8-pin, 2 m
- ZAV50R501, M12×1 connector cable, 8-pin, 5 m
- ZAV50R502, M12×1 connector cable, RJ45, 5 m

## 4. Mounting Instructions

All applicable electrical and mechanical regulations, standards and safety precautions must be adhered to when installing and operating the scanner. The scanner must be protected against mechanical influences. Install the product such that its installation position cannot be inadvertently changed.

## 5. Initial Operation

### 5.1. Initial Operation

Connect the Scanner to supply power (18 to 30 V DC). The display view appears. The Scanner is ready for operation after 2 seconds.

The desired menu language must be selected after initial start-up, and after each reset (see section “6.10. Language” on page 27).

**Note:** If no settings are adjusted in the configuration menu for a period of 30 seconds, the scanner is automatically returned to the display mode.

The Scanner accesses the last used menu view when the key is pressed twice. If a setting is configured, it becomes active as soon as it is changed.

Letters or symbols such as “+” and “-” can also be assigned to the keys within a menu item. Quicker scrolling through numbers is this made possible by pressing and holding the “+” or “-” key.

#### Meaning of the menu items:

- ◀ Back : Move up one level within the menu.
- ◀◀ Run : Switch to the display mode.

## 6. Function Descriptions

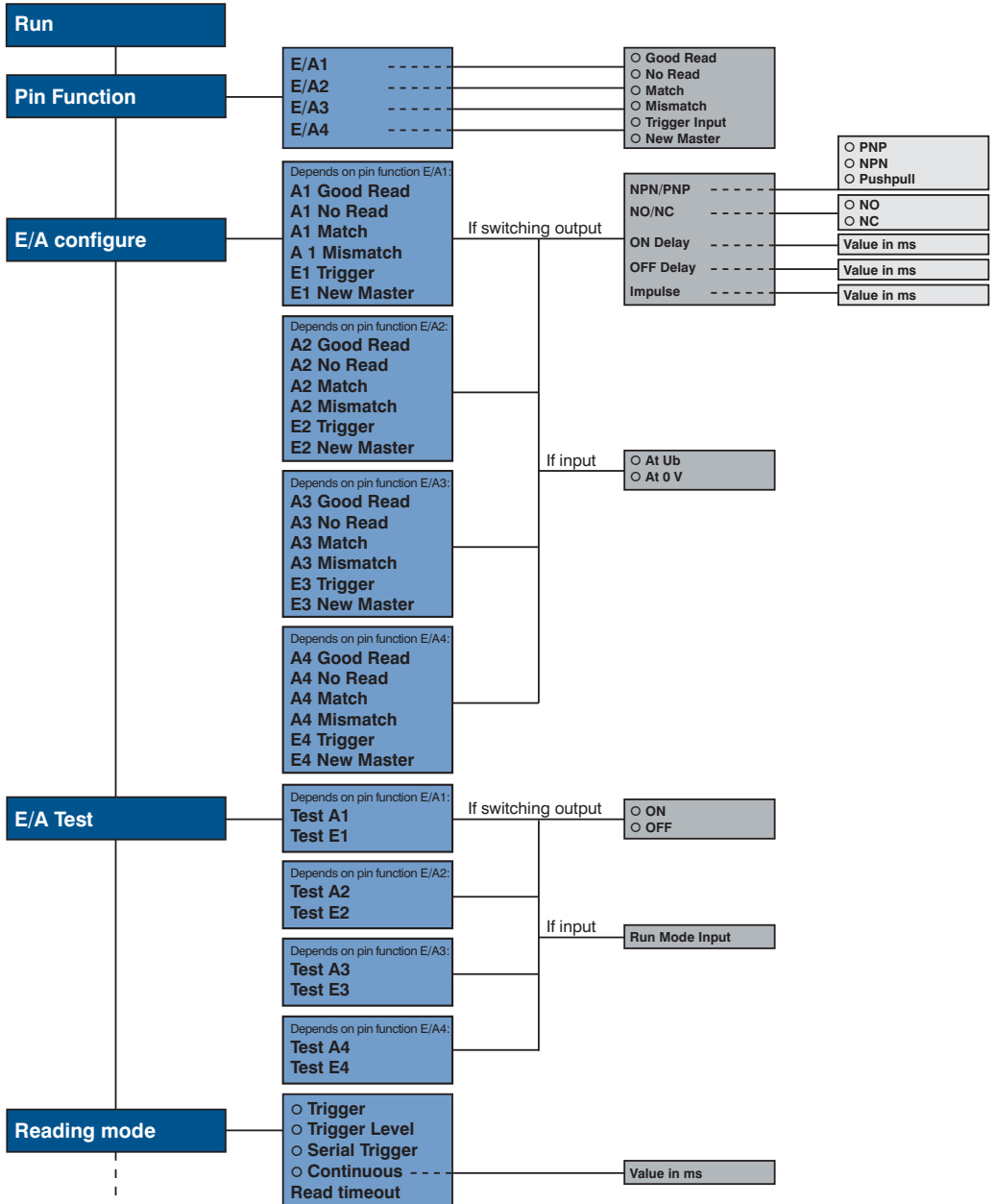

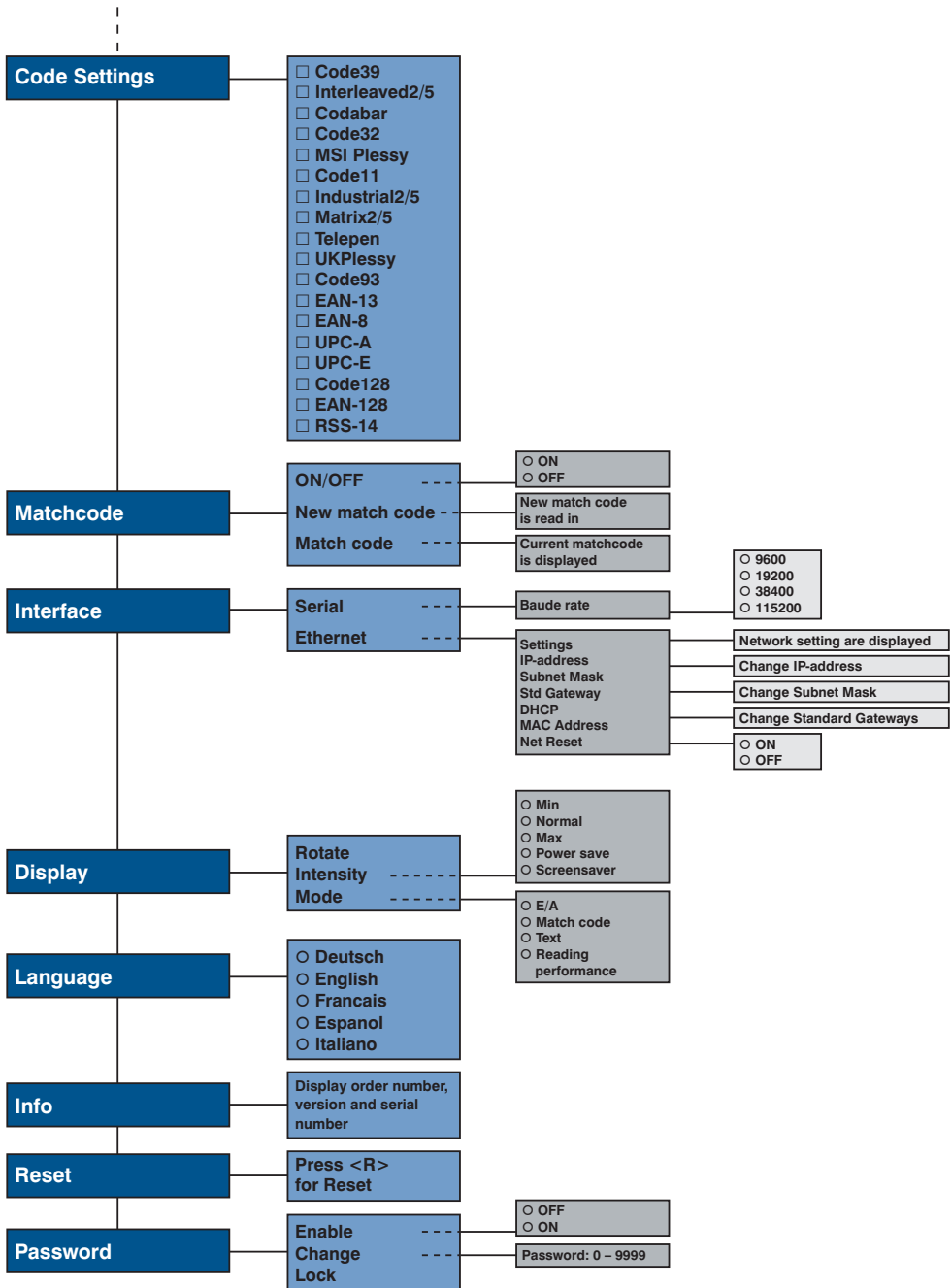



Which functions can be executed with the individual menu options is explained below.

## 6.1. Run

The Scanner is switched to the display mode when the enter key is pressed.

## 6.2. Pin Function

The pin function is used to specify the function assigned to pins E/A1 through E/A4. Various functions can be assigned to the pin.

E/A1	Configuration of Pin E/A1	
<ul style="list-style-type: none"> <li>○ Good Read</li> <li>○ No Read</li> <li>○ Match</li> <li>○ Mismatch</li> <li>○ Trigger Input</li> <li>○ New Master</li> <li>◀ Back</li> <li>◀◀ Run</li> </ul>	<p><b>Good Read:</b></p> <p><b>No Read:</b></p> <p><b>Match:</b></p> <p><b>Mismatch:</b></p> <p><b>Trigger Input:</b></p> <p><b>Master:</b></p>	<p>Switching output for successful read.</p> <p>Switching output for unsuccessful read attempt (only active in trigger mode)</p> <p>Switching output for successful match comparison of a code.</p> <p>Switching output for match comparison without equivalence.</p> <p>Input for triggering the Scanner. The trigger function must be activated with the reading cycle menu option for trigger mode operation.</p> <p>Input for reading a new Match code against which comparison will take place. The next code to be read in becomes a Match code.</p>

## 6.3. E/A Settings

After selecting the pin function, one of the following menus appears.

Each of the menus includes the following items:

### For Good Read

When a pin is configured as a Good Read output, the following functions can be set up:

<ul style="list-style-type: none"> <li>A1 Good Read/</li> <li>A2 Good Read/</li> <li>A3 Good Read/</li> <li>A4 Good Read</li> </ul>	<p>Basic Scanner settings for the individual switching outputs are entered to the <b>A1/A2/A3/A4 Good Read menu.</b></p>	
<ul style="list-style-type: none"> <li>NPN/PNP</li> <li>NO/NC</li> <li>ON Delay</li> <li>OFF Delay</li> <li>Impulse</li> <li>◀ Back</li> <li>◀◀ Run</li> </ul>	<p><b>NPN/PNP:</b></p> <p><b>NO/NC:</b></p> <p><b>ON Delay:</b></p> <p><b>OFF Delay:</b></p> <p><b>Impulse:</b></p>	<p>Output configuration</p> <p>Output configuration</p> <p>ON Delay</p> <p>OFF Delay</p> <p>Pulse Length</p>

## For No Read

<b>A1 No Read/ A2 No Read/ A3 No Read/ A4 No Read</b>	Basic Scanner settings for the individual switching outputs are entered to the <b>A1/A2/A3/A4 No Read menu.</b>
NPN/PNP NO/NC ON Delay OFF Delay Impulse ◀ Back ◀◀ Run	<b>NPN/PNP:</b> Output configuration <b>NO/NC:</b> Output configuration <b>ON Delay:</b> ON Delay <b>OFF Delay:</b> OFF Delay <b>Impulse:</b> Pulse Length

## For Match

When a pin is configured as a Match output, the following functions can be set up:

<b>A1 Match/ A2 Match/ A3 Match/ A4 Match</b>	Basic Scanner settings for the individual switching outputs are entered to the <b>A1/A2/A3/A4 Match menu.</b>
NPN/PNP NO/NC ON Delay OFF Delay Impulse ◀ Back ◀◀ Run	<b>NPN/PNP:</b> Output configuration <b>NO/NC:</b> Output configuration <b>ON Delay:</b> ON Delay <b>OFF Delay:</b> OFF Delay <b>Impulse:</b> Pulse Length

## For Mismatch

When a pin is configured as a Mismatch output, the following functions can be set up:

<b>A1 Mismatch/ A2 Mismatch/ A3 Mismatch/ A4 Mismatch</b>	Basic Scanner settings for the individual switching outputs are entered to the <b>A1/A2/A3/A4 Mismatch menu.</b>
NPN/PNP NO/NC ON Delay OFF Delay Impulse ◀ Back ◀◀ Run	<b>NPN/PNP:</b> Output configuration <b>NO/NC:</b> Output configuration <b>ON Delay:</b> ON Delay <b>OFF Delay:</b> OFF Delay <b>Impulse:</b> Pulse Length

### For Trigger Input

When a pin is configured as a trigger input, the following functions can be set up:

<b>E1 Trigger/ E2 Trigger/ E3 Trigger/ E4 Trigger</b>	Basic Scanner settings for the individual inputs are entered to the <b>E1/E2/E3/E4 Trigger menu</b> .
<input type="radio"/> At Ub <input type="radio"/> At 0 V ◀ Back ◀◀ Run	<b>At Ub:</b> The input is activated when supply power (Ub) is on. <b>At 0 V:</b> The input is activated when supply power is off.

### For New Master

When a pin is configured as a New Master input, the following functions can be set up:

<b>E1 New Master/ E2 New Master/ E3 New Master/ E4 New Master</b>	Basic Scanner settings for the individual inputs are entered to the <b>E1/E2/E3/E4 New Master menu</b> .
<input type="radio"/> At Ub <input type="radio"/> At 0 V ◀ Back ◀◀ Run	<b>At Ub:</b> The input is activated when supply power (Ub) is on. <b>At 0 V:</b> The input is activated when supply power is off.

### 6.3.1. Output – NPN/PNP

<b>NPN/PNP</b>	<b>Configuring the outputs</b>
PNP NPN Pushpull ◀ Back ◀◀ Run	<b>PNP:</b> A load or an analysis module is connected between the minus pole (reference) and the output. When switched, the output is connected to the plus pole via an electronic switch. <b>NPN:</b> A load or an analysis module is connected between the plus pole (reference) and the output. When the scanner is switched, the output is connected to the minus pole via an electronic switch. <b>Pushpull:</b> Push-pull output. Works like an electronic switch, which switches the output alternately to the plus pole or the minus pole.

### 6.3.2. Output – NO/NC

<b>NO/NC</b>	<b>Configuring the outputs</b>
NO NC ◀ Back ◀◀ Run	<b>NO:</b> Normally open contact, light switching. The output is deactivated as soon as the set event (Good Read, Match, Mismatch or No Read) occurs. <b>NC:</b> Normally closed contact, dark switching. The output is activated as soon as the set event (Good Read, Match, Mismatch or No Read) occurs.

### 6.3.3. Output – ON Delay

ON Delay is an adjustable extension of response time.

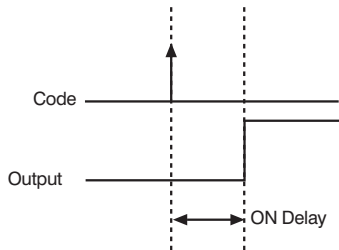

<b>ON Delay</b>	<b>Adjusting ON Delay</b>
<i>ON Delay in ms</i>	ON Delay can be adjusted within a range of 0 to 1000 ms by pressing the “+” or “-” key. Quicker scrolling through numbers is made possible by pressing and holding the respective key.

### 6.3.4. Output – OFF Delay

OFF Delay is time from the occurrence of an event (e.g. reading a code) until the output is deactivated.

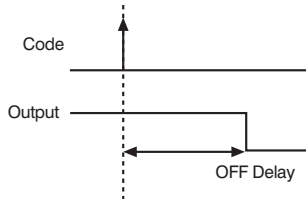

<b>OFF Delay</b>	<b>Adjusting OFF Delay</b>
<i>OFF Delay in ms</i>	OFF Delay can be adjusted by pressing the “+” or “-” key. Quicker scrolling through numbers is made possible by pressing and holding the respective key.

### 6.3.5. Output – Pulse Length

Pulse Length defines the duration of the switching status. This function can be combined with ON Delay.

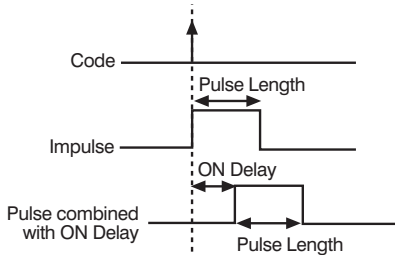

Impulse	Adjusting Pulse Length
<i>Pulse Length in ms</i>	Pulse duration can be adjusted within a range of 0 to 1000 ms by pressing the “+” or “-” key. Quicker scrolling through numbers is made possible by pressing and holding the respective key.

## 6.4. E/A Test

This function changes the outputs manually, regardless of the Scanner’s momentary reading results. This makes it possible to determine whether or not outputs are correctly connected, for example to a controller. It’s also possible to test whether or not voltage is applied to an input pin.

After selecting the pin function, one of the following menus appears.

Each of the menus includes the following items:

E/A Test	E/A: Testing of Inputs and Outputs
Test A1	<b>Test A1:</b> Test output 1
Test A2	<b>Test A2:</b> Test output 2
Test A3	<b>Test A3:</b> Test output 3
Test A4	<b>Test A4:</b> Test output 4
◀ Back	
◀◀ Run	

### 6.4.1. E/A Test – Testing A1 through A4

Test A1/Test A2/ Test A3/Test A4	Activating or Deactivating Outputs
○ ON	<b>ON:</b> Activate output
○ OFF	<b>OFF:</b> Deactivate output
◀ Back	
◀◀ Run	

## 6.4.2. E/A-Test – Testing E1 through E4

<b>Test E1/Test E2/ Test E3/Test E4</b>	<b>Activating or Deactivating Inputs</b>
<i>Symbol</i> ◀ Back ◀◀ Run	The symbol indicates the input's state.

## 6.5. Reading mode

The reading mode function determines the Scanner's reading performance.

<b>Reading mode</b>	<b>The Scanner's reading performance is defined in the Reading Mode menu.</b>
<input type="radio"/> Trigger	<b>Trigger:</b> The Scanner starts the reading procedure after receiving a trigger input signal. An input must be configured as a trigger input to this end, or the corresponding command is transmitted via the interface.
<input type="radio"/> Trigger Level	<b>Trigger Level:</b> The scanner starts the read operation if a trigger input signal is supplied. The read operation is terminated as soon as a code has been decoded or when the trigger input signal disappears.
<input type="radio"/> Serial Trigger	<b>Serial Trigger:</b> When the serial trigger start character is transmitted to the scanner, it starts the reading operation. The reading operation is ended as soon as a code has been deciphered or the serial trigger stop character is transmitted to the scanner.
<input type="radio"/> Continuous	<b>Continuous:</b> The Scanner attempts to read codes without interruption.
Read timeout	<b>Read Timeout:</b> By pressing the "+" or "-" key, a time can be selected during which the Scanner must finish deciphering a code. A duration can be selected within a range of 10 to 10000 ms. Quicker scrolling through numbers is made possible by pressing and holding the respective key.
◀ Back	
◀◀ Run	

## 6.6. Code Settings

Available code algorithms can be activated or deactivated with the Code Settings menu.

Code Settings	Various code algorithms can be activated in the Code Settings menu.
<input type="checkbox"/> Code 39 <input type="checkbox"/> Interleaved 2/5 <input type="checkbox"/> Codabar <input type="checkbox"/> Code32 <input type="checkbox"/> MSIPlessey <input type="checkbox"/> Code11 <input type="checkbox"/> Industrial 2/5 <input type="checkbox"/> Matrix2/5 <input type="checkbox"/> Telepen <input type="checkbox"/> UKPlessey <input type="checkbox"/> Code93 <input type="checkbox"/> EAN-13 <input type="checkbox"/> EAN-8 <input type="checkbox"/> UPC-A <input type="checkbox"/> UPC-E <input type="checkbox"/> Code128 <input type="checkbox"/> EAN-128 <input type="checkbox"/> RSS-14 ◀ Back ◀◀ Run	Activates or deactivates the respective code algorithm. The respective codes are described in more detail beginning with section “8.5. Code Settings” on page 36

## 6.7. Match code

The Match code function makes it possible to save reference codes (master codes) to memory, and to check other codes against them during operation.

Match code	The settings for the Match code function are selected in the Match code menu
ON/OFF New match code Match code ◀ Back ◀◀ Run	<b>ON/OFF:</b> Switches the match code function on or off. <b>New match code:</b> After pressing the “◀” key, the next code which is scanned is taught in as a match code. <b>Match code:</b> The currently saved match code is displayed by pressing the enter key.

## 6.8. Interface

Interface	Basic Interface Settings
Serial Ethernet ◀ Back ◀◀ Run	<b>Serial:</b> Basic settings for the serial port <b>Ethernet:</b> Basic settings for the Ethernet interface

### 6.8.1. Serial/Baude rate

Baude rate	Setting the Baude rate
○ 9600	<b>9600:</b> 9600 Baud (default setting)
○ 19200	<b>19200:</b> 19200 Baud
○ 38400	<b>38400:</b> 38400 Baud
○ 115200	<b>115200:</b> 115200 Baud
◀ Back	
◀◀ Run	

### 6.8.2. Ethernet

Ethernet	Settings for the Ethernet Interface
Settings	<b>Settings:</b> Current network settings are displayed. You can scroll through the settings by pressing the navigation keys.
IP-address	<b>IP-address:</b> IP address setting
Subnet mask	<b>Subnet mask:</b> Subnet mask setting
Std gateway	<b>Standard gateway:</b> Standard gateway setting
DHCP	<b>DHCP:</b> Activate or deactivate the DHCP client
MAC address	<b>MAC address:</b> Displays the Scanner's MAC address
Net Reset	<b>Net Reset:</b> Network settings are restored to their default values
Accept	
Cancel	

Default values for network settings:

IP-address: 192.168.100.1  
 Subnet mask: 255.255.255.0  
 Standard gateway 192.168.100.254

#### 6.8.2.1. IP-address

IP-address	Setting the IP-address
IP-address	The individual octets in the IP-address can be selected by pressing the "+" and "-" keys. You can jump to the next octet by pressing the "◀" key. Quicker scrolling through numbers is made possible by pressing and holding the respective key.

#### 6.8.2.2. Subnet mask

Subnet mask	Setting the Subnet mask
Subnet mask	The individual octets in the Subnet mask can be selected by pressing the "+" and "-" keys. You can jump to the next octet by pressing the "◀" key. Quicker scrolling through numbers is made possible by pressing and holding the respective key.



### 6.8.2.3. Standard Gateway

<b>Standard gateway</b>	<b>Setting the Standard gateway</b>
<i>Standard gateway</i>	The individual octets in the Standard gateway can be selected by pressing the “+” and “-” keys. You can jump to the next octet by pressing the “◀” key. Quicker scrolling through numbers is made possible by pressing and holding the respective key.

### 6.8.2.4. DHCP

<b>DHCP</b>	<b>DHCP Setting</b>
<input type="radio"/> ON <input type="radio"/> OFF ◀ Back ◀◀ Run	Activate or deactivate the integrated DHCP client.

### 6.8.2.5. MAC Address

<b>MAC Address</b>	<b>Display the MAC Address</b>
<i>MAC Address</i>	The Scanner’s MAC address is displayed.

### 6.8.2.6. Network Reset

<b>Ethernet</b>	<b>Resetting Network Settings</b>
<i>Net Reset</i>	The network settings are reset as soon as the menu is exited with the accept key.

### 6.8.2.7. Accept

<b>Ethernet</b>	<b>Accepting Settings</b>
<i>Accept</i>	All network settings are accepted. The Scanner reboots in order to accept the settings.

### 6.8.2.8. Cancel

<b>Ethernet</b>	<b>Accepting Settings</b>
<i>Cancel</i>	All of the settings in the Ethernet menu are discarded. No changes are made to the network settings.

## 6.9. Display

Display	Setting the Display
Rotate Intensity Mode ◀ Back ⏪ Run	<p><b>Rotate:</b> Rotate the display 180°. The display is rotated 180° by pressing the ◀ key. The display can be returned to its original position by pressing the same key once again.</p> <p><b>Intensity:</b> Adjust display intensity.</p> <p><b>Mode:</b> Select display mode.</p>

### 6.9.1. Display – Mode

Mode	Selecting a Display Mode
<input type="radio"/> E/A <input type="radio"/> Match code <input type="radio"/> Text <input type="radio"/> Reading performance ◀ Back ⏪ Run	<p><b>E/A:</b> The statuses of the individual inputs and outputs, as well as the last code to be read in, are displayed.</p> <p><b>Match code:</b> The taught in master code and the currently scanned code appear at the display. If the two codes match up with each other, the master code is displayed inversely.</p> <p><b>Text:</b> A freely selectable text can be written to the display by means of an interface command. The last code to be read in is displayed as well.</p> <p><b>Reading performance:</b> Reading performance is displayed in scans per second, and as a percentage. Calculation of reading performance is deactivated as a default setting. It can be activated via the web-based configuration or by means of an interface command.</p>

### 6.9.2. Display – Intensity

Intensity	Setting Display intensity
<input type="radio"/> Min <input type="radio"/> Normal <input type="radio"/> Max <input type="radio"/> Power save <input type="radio"/> Screensaver ◀ Back ⏪ Run	<p><b>Min:</b> Minimum intensity. The display's intensity is set to a minimal value.</p> <p><b>Normal:</b> Normal intensity. The display's intensity is set to a medium value.</p> <p><b>Max:</b> Maximum intensity. The display's intensity is set to the maximum value.</p> <p><b>Power save:</b> Energy saving mode. If no keys are pressed for a period of one minute, the display is switched off and is automatically switched back on as soon as a key is activated.</p> <p><b>Screensaver:</b> The display is inverted once a minute.</p>

## 6.10. Language

The menu language can be changed in the “Language” menu. The user is automatically prompted to select a language when the Scanner is first started up, as well as after a reset.

Language	Selecting a Menu Language
<ul style="list-style-type: none"> <li>○ Deutsch</li> <li>○ English</li> <li>○ Français</li> <li>○ Español</li> <li>○ Italiano</li> <li>◀ Back</li> <li>◀◀ Run</li> </ul>	The desired language appears in the menus as soon as it has been selected.

## 6.11. Info

The following information regarding the Scanner is displayed in the “Info” menu:

Info	
<ul style="list-style-type: none"> <li>Order number</li> <li>Software version</li> <li>Serial number</li> </ul>	

## 6.12. Reset

Scanner settings can be returned to their default values with the help of the “Reset” menu.

Reset	Reset: Restore Default Settings
Press <R> for Reset	All of the selected Scanner settings are returned to their default values by pressing the “R” key.

## 6.13. Password

Password protection prevents inadvertent changes to selected settings.

Password	Activating the Password Function
<ul style="list-style-type: none"> <li>Enable</li> <li>Change</li> <li>Lock</li> <li>◀ Back</li> <li>◀◀ Run</li> </ul>	<p><b>Enable:</b> Switch password function ON or OFF.</p> <p><b>Change:</b> Change the password.</p> <p><b>Lock:</b> Invalidating the password disables operation immediately, if “Activate password” is set to on.</p>

If the password function has been activated. The password must be entered each time supply power to the Scanner is interrupted. After the password has been correctly entered with the “+” and “-” keys, the menu is enabled and the Scanner can be operated.

- The password function is deactivated upon shipment from the factory.
- Passwords can be selected within a range of 0000 to 9999.

Be sure to make a note of the new password before exiting the “change password” function! If the password is forgotten, it must be overwritten with a master password. The master password can be requested by e-mail from **support@wenglor.com**.

## 7. Network Settings

In order to operate the Scanner at an Ethernet LAN, the Scanner and the remote station, for example a computer, must be located in the same network. The Scanner’s IP address is set to 192.168.100.1, its subnet mask is set to 255.255.255.0 and the standard gateway is set to 192.168.100.254. The operating instructions always assume that these default values are used.

## 8. Web-Based Configuration

The Scanner is equipped with a web-based configuration interface which functions independent of certain operating systems. You can configure the Scanner conveniently at a standard web browser.

### 8.1. Invoking the Administration Interface

Start the web browser. Enter the IP address of the Scanner to the address line in your browser and press the enter key. The Scanner’s IP address is preset to 192.168.100.1.

**Example:** `http://192.168.100.1`

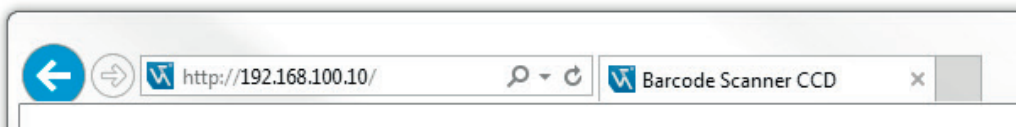

The **General Device** overview page is not password protected. A password prompt appears when other pages are accessed.

The following user data are preset upon shipment from the factory.

**User name:** admin  
**Password:** admin

The password can be changed in the Device Settings page.

## 8.2. Overview Page

After a connection has been established, the Scanner's overview page is displayed.

 **wenglor**  
the innovative family

English

- [General device](#)
- [Device settings](#)
- [Read cycle](#)
- [Code settings](#)
- [Digital I/O settings](#)
- [Diagnosis](#)

General device



Part Number	BLN0L1R10
Firmware Revision	v 1.5.0
Producer	wenglor sensoric GmbH
Description	Barcode Scanner CCD
Serial number	510040159
MAC address	54-4A-05-02-51-DA

© wenglor sensoric GmbH

The website can be changed from English (default language) to German with the language selection function.

## 8.3. Device Settings

After clicking “Accept Network Settings”, the settings are accepted and the scanner reboots. The RS-232 port, the Ethernet interface and the TCP socket application are parameters configuring interfaces.

<ul style="list-style-type: none"><li>• <a href="#">General device</a></li><li>• <a href="#">Device settings</a></li><li>• <a href="#">Read cycle</a></li><li>• <a href="#">Code settings</a></li><li>• <a href="#">Digital I/O settings</a></li><li>• <a href="#">Diagnosis</a></li></ul>	<h3>Device settings</h3> <p>Network Settings</p> <p><input type="radio"/> Get IP address automatically <input checked="" type="radio"/> Use following IP addresses:</p> <table><tr><td>IP-address</td><td><input type="text" value="192.168.100.1"/></td><td></td></tr><tr><td>Subnet mask</td><td><input type="text" value="255.255.255.0"/></td><td><input type="button" value="Send"/></td></tr><tr><td>Standard gateway</td><td><input type="text" value="192.168.100.254"/></td><td></td></tr></table> <table><tr><td>TCP Port</td><td><input type="text" value="2000"/></td><td><input type="button" value="Send"/></td></tr></table> <table><tr><td>Device name</td><td><input type="text" value="BLN0L1R10"/></td><td><input type="button" value="Send"/></td></tr></table> <p>Serial interface</p> <table><tr><td>Baud Rate:</td><td><input type="text" value="9600"/></td><td>▼</td></tr><tr><td>Data bits:</td><td><input type="text" value="8"/></td><td>▼</td></tr><tr><td>Parity:</td><td><input type="text" value="None"/></td><td>▼</td></tr><tr><td>Stop bits</td><td><input type="text" value="1"/></td><td>▼</td></tr></table> <p>Display settings</p> <table><tr><td>Language</td><td><input type="text" value="German"/></td><td>▼</td></tr><tr><td>Rotate display</td><td><input type="text" value="Off"/></td><td>▼</td></tr><tr><td>Display intensity</td><td><input type="text" value="ScreenSaver"/></td><td>▼</td></tr><tr><td>Display mode</td><td><input type="text" value="EA"/></td><td>▼</td></tr></table> <table><tr><td>Do reset</td><td><input type="button" value="Reset"/></td></tr></table> <table><tr><td>Change password</td><td><input type="button" value="Change"/></td></tr></table> <p>Trigger</p> <table><tr><td>Trigger character</td><td><input type="text" value="T"/></td><td><input type="button" value="Send"/></td></tr><tr><td>Trigger reply</td><td><input type="text" value="On"/></td><td>▼</td></tr><tr><td>Trigger serial start character</td><td><input type="text" value="1"/></td><td><input type="button" value="Send"/></td></tr><tr><td>Trigger serial stop character</td><td><input type="text" value="2"/></td><td><input type="button" value="Send"/></td></tr></table> <p>Service message</p> <table><tr><td>Service message</td><td><input type="text" value="Off"/></td><td>▼</td></tr><tr><td>Service message</td><td><input type="text" value="Service"/></td><td><input type="button" value="Send"/></td></tr><tr><td>Sending interval in sec.</td><td><input type="text" value="60"/></td><td><input type="button" value="Send"/></td></tr></table>	IP-address	<input type="text" value="192.168.100.1"/>		Subnet mask	<input type="text" value="255.255.255.0"/>	<input type="button" value="Send"/>	Standard gateway	<input type="text" value="192.168.100.254"/>		TCP Port	<input type="text" value="2000"/>	<input type="button" value="Send"/>	Device name	<input type="text" value="BLN0L1R10"/>	<input type="button" value="Send"/>	Baud Rate:	<input type="text" value="9600"/>	▼	Data bits:	<input type="text" value="8"/>	▼	Parity:	<input type="text" value="None"/>	▼	Stop bits	<input type="text" value="1"/>	▼	Language	<input type="text" value="German"/>	▼	Rotate display	<input type="text" value="Off"/>	▼	Display intensity	<input type="text" value="ScreenSaver"/>	▼	Display mode	<input type="text" value="EA"/>	▼	Do reset	<input type="button" value="Reset"/>	Change password	<input type="button" value="Change"/>	Trigger character	<input type="text" value="T"/>	<input type="button" value="Send"/>	Trigger reply	<input type="text" value="On"/>	▼	Trigger serial start character	<input type="text" value="1"/>	<input type="button" value="Send"/>	Trigger serial stop character	<input type="text" value="2"/>	<input type="button" value="Send"/>	Service message	<input type="text" value="Off"/>	▼	Service message	<input type="text" value="Service"/>	<input type="button" value="Send"/>	Sending interval in sec.	<input type="text" value="60"/>	<input type="button" value="Send"/>
IP-address	<input type="text" value="192.168.100.1"/>																																																																
Subnet mask	<input type="text" value="255.255.255.0"/>	<input type="button" value="Send"/>																																																															
Standard gateway	<input type="text" value="192.168.100.254"/>																																																																
TCP Port	<input type="text" value="2000"/>	<input type="button" value="Send"/>																																																															
Device name	<input type="text" value="BLN0L1R10"/>	<input type="button" value="Send"/>																																																															
Baud Rate:	<input type="text" value="9600"/>	▼																																																															
Data bits:	<input type="text" value="8"/>	▼																																																															
Parity:	<input type="text" value="None"/>	▼																																																															
Stop bits	<input type="text" value="1"/>	▼																																																															
Language	<input type="text" value="German"/>	▼																																																															
Rotate display	<input type="text" value="Off"/>	▼																																																															
Display intensity	<input type="text" value="ScreenSaver"/>	▼																																																															
Display mode	<input type="text" value="EA"/>	▼																																																															
Do reset	<input type="button" value="Reset"/>																																																																
Change password	<input type="button" value="Change"/>																																																																
Trigger character	<input type="text" value="T"/>	<input type="button" value="Send"/>																																																															
Trigger reply	<input type="text" value="On"/>	▼																																																															
Trigger serial start character	<input type="text" value="1"/>	<input type="button" value="Send"/>																																																															
Trigger serial stop character	<input type="text" value="2"/>	<input type="button" value="Send"/>																																																															
Service message	<input type="text" value="Off"/>	▼																																																															
Service message	<input type="text" value="Service"/>	<input type="button" value="Send"/>																																																															
Sending interval in sec.	<input type="text" value="60"/>	<input type="button" value="Send"/>																																																															

### TCP port settings:

The TCP Port selection specifies via which port a TCP connection can be established. Only one TCP connection is possible.

TCP Port	<input type="text" value="2000"/>	<input type="button" value="Send"/>
----------	-----------------------------------	-------------------------------------

A unique device name can be assigned to each Scanner. The device name appears in the first line of the OLED display.

Device name	<input type="text" value="BLN0L1R10"/>	<input type="button" value="Send"/>
-------------	--	-------------------------------------

### Parameters for the serial port:

Serial interface	
Baud Rate:	<input type="text" value="9600"/>
Data bits:	<input type="text" value="8"/>
Parity:	<input type="text" value="None"/>
Stop bits	<input type="text" value="1"/>

### Parameters for the OLED display:

Display settings	
Language	<input type="text" value="German"/>
Rotate display	<input type="text" value="Off"/>
Display intensity	<input type="text" value="ScreenSaver"/>
Display mode	<input type="text" value="EA"/>

Parameters are identical to those of the OLED display, see section [“6.9. Display”](#) on page 26.

### Reset:

Do reset	<input type="button" value="Reset"/>
----------	--------------------------------------

### Change password:

Change password	<input type="button" value="Change"/>
-----------------	---------------------------------------

An additional window appears to which the new password can be entered.

### Parameter Trigger:

Trigger	
Trigger character	T <input type="text"/> <input type="button" value="Send"/>
Trigger reply	On ▾
Trigger serial start character	1 <input type="text"/> <input type="button" value="Send"/>
Trigger serial stop character	2 <input type="text"/> <input type="button" value="Send"/>

The letter can be selected which, in combination with the interface protocol, is used to trigger the scanner. If trigger response is activated, the scanner returns a response to the trigger command.

The letters can be specified which, in combination with the interface protocol, start or stop the reading operation in the “serial trigger” mode.

### Parameter service message:

Service message	
Service message	Off ▾
Service message	Service <input type="text"/> <input type="button" value="Send"/>
Sending interval in sec.	60 <input type="text"/> <input type="button" value="Send"/>

If the service message function is enabled, the set service message is sent via the serial and Ethernet interface after the transmission interval has elapsed.

Reading performance	
Reading performance	Off ▾
Reading performance interval in sec.	5 <input type="text"/> <input type="button" value="Send"/>
Trigger reply	On ▾

After the reading performance function has been activated, reading performance is read out via the serial and Ethernet interfaces as a percentage after the interval has elapsed, as well as in scans per second. If the reading quality display mode is activated at the same time, reading performance also appears at the OLED display.



## 8.4. Read Cycle

<ul style="list-style-type: none"> <li>• General device</li> <li>• Device settings</li> <li>• <b>Read cycle</b></li> <li>• Code settings</li> <li>• Digital I/O settings</li> <li>• Diagnosis</li> </ul>	Read cycle	
	Reading mode	Continuous mode ▾
	Read timeout	1000 ms <input type="button" value="Send"/>
	Code ID	Off ▾
	Code Length	Off ▾
	Preamble Code	Off ▾
	Preamble character 1	<input type="text"/> <input type="button" value="Send"/>
	Preamble character 2	<input type="text"/> <input type="button" value="Send"/>
	Preamble character 3	<input type="text"/> <input type="button" value="Send"/>
	Preamble character 4	<input type="text"/> <input type="button" value="Send"/>
	Preamble character 5	<input type="text"/> <input type="button" value="Send"/>
	Postamble Code	Off ▾
	Postamble character 1	<input type="text"/> <input type="button" value="Send"/>
	Postamble character 2	<input type="text"/> <input type="button" value="Send"/>
	Postamble character 3	<input type="text"/> <input type="button" value="Send"/>
	Postamble character 4	<input type="text"/> <input type="button" value="Send"/>
	Postamble character 5	<input type="text"/> <input type="button" value="Send"/>
	Terminator 1	13 <input type="button" value="Send"/>
	Terminator 2	10 <input type="button" value="Send"/>
	Matchcode settings	
Match code	Off ▾	
Current Match Code	<input type="text"/> <input type="button" value="Send"/>	
Replace Code in case of Match	Off ▾	
Replace by text	MATCH <input type="text"/> <input type="button" value="Send"/>	
Replace Code in case of Mismatch	Off ▾	
Replace by text	MISMATCH <input type="text"/> <input type="button" value="Send"/>	
NoRead settings		
NoRead	Off ▾	
NoRead message	NoRead <input type="text"/> <input type="button" value="Send"/>	

### 8.4.1. Reading mode

Reading mode	Continuous mode ▾
--------------	-------------------

Read mode settings. Trigger, trigger level and permanent operation are available. Parameters are identical to those of the OLED display as described in section “6.5. Reading mode” on page 22.

### 8.4.2. Read timeout

Configures the time, that the scanner may use for the decoding of a code. The time duration can be set in 1 ms steps.

### 8.4.3. Code

Code ID	Off	▼
Code Length	Off	▼

Activation of transmission of the code ID and the scanned code length.

### 8.4.4. Preamble and Postamble Characters

Preamble Code	Off	▼
Preamble character 1	<input type="text"/>	<input type="button" value="Send"/>
Preamble character 2	<input type="text"/>	<input type="button" value="Send"/>
Preamble character 3	<input type="text"/>	<input type="button" value="Send"/>
Preamble character 4	<input type="text"/>	<input type="button" value="Send"/>
Preamble character 5	<input type="text"/>	<input type="button" value="Send"/>
Postamble Code	Off	▼
Postamble character 1	<input type="text"/>	<input type="button" value="Send"/>
Postamble character 2	<input type="text"/>	<input type="button" value="Send"/>
Postamble character 3	<input type="text"/>	<input type="button" value="Send"/>
Postamble character 4	<input type="text"/>	<input type="button" value="Send"/>
Postamble character 5	<input type="text"/>	<input type="button" value="Send"/>

Characters can be added to the left (preamble) and to the right (postamble) of the scanned code. Desired characters have to be entered as numeric values (ASCII decimal representation). To delete a prefix or postamble character, 0 must be sent to the scanner. An ASCII table is included in the appendix.

### 8.4.5. Match code Parameters

Matchcode settings			
Match code	Off	▼	
Current Match Code	<input type="text"/>	<input type="button" value="Send"/>	
Replace Code in case of Match	Off	▼	
Replace by text	MATCH	<input type="text"/>	<input type="button" value="Send"/>
Replace Code in case of Mismatch	Off	▼	
Replace by text	MISMATCH	<input type="text"/>	<input type="button" value="Send"/>

### 8.4.6. Terminator

Characters can be added to the read code. The desired characters have to be registered as digit value (ASCII decimal display). An ASCII table can be found in the appendix.

### 8.4.7. Match code

Match code	Off ▼
------------	-------

Activate or deactivate the match code function.

### 8.4.8. Current Match code

Current Match Code	<input type="text"/>	Send
--------------------	----------------------	------

The currently taught in match code is displayed. The match code can be changed in the entry field. Only alphanumeric characters can be used. The new match code is transmitted to the Scanner by clicking the send button.

### 8.4.9. Match and Mismatch Performance

Replace Code in case of Match	Off ▼
Replace by text	MATCH <input type="text"/> Send
Replace Code in case of Mismatch	Off ▼
Replace by text	MISMATCH <input type="text"/> Send

The “replace code in case of match or mismatch” function can be used to determine whether or not the scanned code will be replaced with a message, and if so which message will be displayed. Only alphanumeric characters can be used.

### What happens if the read operation fails?

NoRead settings	
NoRead	Off ▼
NoRead message	NoRead <input type="text"/> Send

If the NoRead function is enabled, the scanner sends the NoRead text via the serial and Ethernet interface if a code could not be read within the read timeout.

## 8.5. Code Settings

Available code algorithms can be activated or deactivated with the Symbols menu. After clicking an individual code, additional setting options appear for the respective code.

<ul style="list-style-type: none"><li>• <a href="#">General device</a></li><li>• <a href="#">Device settings</a></li><li>• <a href="#">Read cycle</a></li><li>• <a href="#">Code settings</a></li><li>• <a href="#">Digital I/O settings</a></li><li>• <a href="#">Diagnosis</a></li></ul>	<h3>Code settings</h3> <p>Symbologies</p> <p>Code 39 <input type="button" value="On"/> ▾</p> <p>Code 11 <input type="button" value="Off"/> ▾</p> <p>Code 128 <input type="button" value="On"/> ▾</p> <p>Interleaved 2 of 5 <input type="button" value="On"/> ▾</p> <p>Codabar <input type="button" value="On"/> ▾</p> <p>UPC/EAN</p> <p>Code 93 <input type="button" value="Off"/> ▾</p> <p>Industrial 2 of 5 <input type="button" value="Off"/> ▾</p> <p>MSI Code</p> <p>RSS-14 Expanded <input type="button" value="Off"/> ▾</p> <p>RSS-14 Limited <input type="button" value="Off"/> ▾</p> <p>RSS-14 Omnidirectional <input type="button" value="Off"/> ▾</p> <p>Matrix 2 of 5 <input type="button" value="Off"/> ▾</p>
--	--

### 8.5.1. Code 39

Code 39 is a standard code except for commercial applications. It's capable of portraying alphanumeric symbols. The code includes definitive start and stop characters and is made up of 9 black and white elements per line, of which 3 are wide.

Standard code 39 supports 43 characters: 0 to 9, uppercase letters A through Z, \$, :, /, ., + and -.

### 8.5.2. Code 11

Code 11 is a numeric code with start and stop characters. The code is secured by means of a checksum. It's used primarily in the communications industry.

### 8.5.3. Code 128

This is a highly dense alphanumeric code. It's capable of encrypting all 128 ASCII characters. Various wide elements are used in the code. The code has a variable length.

#### 8.5.4. Interleaved 2 of 5

A dense, continuous, self-checking numeric barcode. The characters are combined in pairs, so that each character consists of five elements (two wide and three narrow), each of which can be assigned values within a range of 1 to 9. The bars represent the first character and the spaces the second. (A check digit is highly recommended in this case).

#### 8.5.5. Codabar

Codabar involves a 16 bit character set (0 to 9 and the following characters: \$, :, /, ., + and -). This code has start and stop characters, and at least two bar widths which differ from each other greatly. The Codabar barcode is used primarily in libraries and in the field of health care, but it's being replaced to an ever greater extent by more up-to-date codes due to high error frequencies.

#### 8.5.6. UPC/EAN

EAN (European article number) is a product identifier used in commercial applications. An EAN code consists of 13 or 8 characters. It's administrated centrally by the GS1 Association and is assigned upon application by the manufacturer. The EAN code is also known as the GTIN (global trade item number). UPC (universal product code) is a compatible code which is used primarily in the USA and Canada. The last character is the checksum character.

#### 8.5.7. Code 93

Code 93 evolved as a further development of code 39. However, its layout is more like that of code 128. Code 93 has the greatest character density for alphanumeric encoding of all linear barcodes.

#### 8.5.8. Industrial 2 of 5

Industrial 2 of 5 is used primarily in warehouses, photographic laboratories and for airline ticketing applications. The characters are combined in pairs, so that each character consists of five elements (two wide and three narrow), each of which can be assigned values within a range of 1 to 9. The bars represent the first character and the spaces the second.

#### 8.5.9. MSI Code

MSI Code is a numeric code, and each character consists of 4 bits in binary format.

#### 8.5.10. RSS-14 Expanded

RSS-14 Expanded is the most variable variant of the RSS-14 family. It has at least 4 and no more than 22 code words, which are used to encode data, additional information and a check digit. The code words consist of 17 modules and are represented with 4 spaces and 4 bars. The search patterns have 15 modules which are broken down into 3 spaces and 2 bars. Spaces and bars are represented in 8 different module widths, i.e. the elements can have widths ranging from 1X to 8X. RSS-14 Expanded can be read omnidirectionally. The code is very compact with a reliable layout. It requires very little space because no unnecessary overhang is included in the code. Depending on length, the code can be reconstructed by means of several segment scans.

### **8.5.11. RSS-14 Limited**

RSS-14 Limited consists of 74 modules subdivided into 46 elements. The code words consist of 26 modules and are represented with 7 spaces and 7 bars. the search pattern has 18 modules. Spaces and bars are represented in 8 different module widths, i.e. the elements can have widths ranging from 1X to 8X. Cannot be read omnidirectionally and has no application identifier.

### **8.5.12. RSS-14 Omnidirectional**

RSS-14 provides the basic structure for the extended UCC/EAN system. Application identifier "01" and a 14 digit article number can be encoded with RSS-14. All RSS-14 codes have a link flag. If the flag is set to 1, a composite code is involved. Two codes have to be read in this case. RSS-14 consists of 94 modules subdivided into 46 elements. The code words consist of 15 or 16 modules and are represented with 4 spaces and 4 bars. the search pattern has 14 modules. Spaces and bars are represented in 8 different module widths, i.e. the elements can have widths ranging from 1X to 8X.

### **8.5.13. Matrix 2 of 5**

Matrix 2 of 5 code is also a member of the 2 of 5 code family. Its layout is comparable to that of Interleaved 2 of 5 and Industrial 2 of 5.

## 8.6. Digital I/O Settings

<ul style="list-style-type: none"> <li>• General device</li> <li>• Device settings</li> <li>• Read cycle</li> <li>• Code settings</li> <li>• Digital I/O settings</li> <li>• Diagnosis</li> </ul>	Digital I/O settings							
	<table border="1"> <tr> <td>E/A1</td> <td>E/A2</td> <td>E/A3</td> <td>E/A4</td> </tr> </table>	E/A1	E/A2	E/A3	E/A4	Configuration		
E/A1	E/A2	E/A3	E/A4					

The inputs/outputs have no function upon shipment from the factory.

Configuration as output:

<ul style="list-style-type: none"> <li>• General device</li> <li>• Device settings</li> <li>• Read cycle</li> <li>• Code settings</li> <li>• Digital I/O settings</li> <li>• Diagnosis</li> </ul>	Digital I/O settings							
	<table border="1"> <tr> <td>E/A1</td> <td>E/A2</td> <td>E/A3</td> <td>E/A4</td> </tr> </table>	E/A1	E/A2	E/A3	E/A4	Configuration		
E/A1	E/A2	E/A3	E/A4					
Polarity				NO ▾				
Mode				PNP ▾				
On-Delay				0 ms <a href="#">Send</a>				
Off-Delay				50 ms <a href="#">Send</a>				
Impulse				50 ms <a href="#">Send</a>				
Test				Off ▾				

Configuration as input:

<ul style="list-style-type: none"> <li>• General device</li> <li>• Device settings</li> <li>• Read cycle</li> <li>• Code settings</li> <li>• Digital I/O settings</li> <li>• Diagnosis</li> </ul>	Digital I/O settings							
	<table border="1"> <tr> <td>E/A1</td> <td>E/A2</td> <td>E/A3</td> <td>E/A4</td> </tr> </table>	E/A1	E/A2	E/A3	E/A4	Configuration		
E/A1	E/A2	E/A3	E/A4					
Polarity				UB ▾				

## 8.7. Diagnosis

<ul style="list-style-type: none"><li>• <a href="#">General device</a></li><li>• <a href="#">Device settings</a></li><li>• <a href="#">Read cycle</a></li><li>• <a href="#">Code settings</a></li><li>• <a href="#">Digital I/O settings</a></li><li>• <a href="#">Diagnosis</a></li></ul>	<h3>Diagnosis</h3> <table><tr><td colspan="2">Network</td></tr><tr><td>Transmitted package</td><td>623</td></tr><tr><td>Received packets</td><td>336</td></tr><tr><td>Rejected packets</td><td>0</td></tr><tr><td colspan="2">Scanner</td></tr><tr><td>Trigger</td><td>0</td></tr><tr><td>Good Read</td><td>0</td></tr><tr><td>No Read</td><td>0</td></tr><tr><td>Match</td><td>0</td></tr><tr><td>Mismatch</td><td>0</td></tr></table> <p><a href="#">Update page</a></p>	Network		Transmitted package	623	Received packets	336	Rejected packets	0	Scanner		Trigger	0	Good Read	0	No Read	0	Match	0	Mismatch	0
Network																					
Transmitted package	623																				
Received packets	336																				
Rejected packets	0																				
Scanner																					
Trigger	0																				
Good Read	0																				
No Read	0																				
Match	0																				
Mismatch	0																				

Various Scanner statistics are displayed.

## 9. Maintenance Instructions

- This wenglor Scanner is maintenance-free.
- It is advisable to clean the lens and the display, and to check the plug connections at regular intervals.
- Do not clean with solvents or cleansers which could damage the device.

## 10. Proper Disposal

wenglor sensoric gmbh does not accept the return of unusable or irreparable products. Respectively valid national waste disposal regulations apply to product disposal.



Dez	ASCII	Dez	ASCII	Dez	ASCII	Dez	ASCII
0	NUL	32	SP	64	@	96	`
1	SOH	33	!	65	A	97	a
2	STX	34	"	66	B	98	b
3	ETX	35	#	67	C	99	c
4	EOT	36	\$	68	D	100	d
5	ENQ	37	%	69	E	101	e
6	ACK	38	&	70	F	102	f
7	BEL	39	'	71	G	103	g
8	BS	40	(	72	H	104	h
9	TAB	41	)	73	I	105	i
10	LF	42	*	74	J	106	j
11	VT	43	+	75	K	107	k
12	FF	44	,	76	L	108	l
13	CR	45	-	77	M	109	m
14	SO	46	.	78	N	110	n
15	SI	47	/	79	O	111	o
16	DLE	48	0	80	P	112	p
17	DC1	49	1	81	Q	113	q
18	DC2	50	2	82	R	114	r
19	DC3	51	3	83	S	115	s
20	DC4	52	4	84	T	116	t
21	NAK	53	5	85	U	117	u
22	SYN	54	6	86	V	118	v
23	ETB	55	7	87	W	119	w
24	CAN	56	8	88	X	120	x
25	EM	57	9	89	Y	121	y
26	SUB	58	:	90	Z	122	z
27	ESC	59	;	91	[	123	{
28	FS	60	<	92	\	124	
29	GS	61	=	93	]	125	}
30	RS	62	>	94	^	126	~
31	US	63	?	95	_	127	DEL

## 11. EU Declaration of Conformity

The EU declaration of conformity can be found on our website at [www.wenglor.com](http://www.wenglor.com) in download area.

## 12. Change Index, Operating Instructions

Version	Date	Description/Change
1.0.0	30.09.2020	Initial version of the operating instructions
1.0.1	11.11.2020	Completion in section <a href="#">"8.4.3. Code"</a> on page 34